

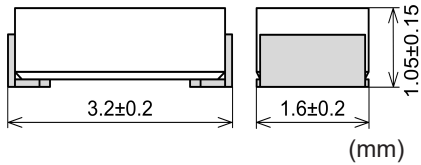

Dimensions and construction:



Case: Ceramic
 Cover: Ceramic
 Terminal substrate metal: Copper t=0.1 mm
 Terminal primary plating: Nickel plated copper, 0.5 µm or more
 Terminal surface plating: Tin plated, 2 µm or more
 Adhesive: Epoxy resin
 Marking: SOC
 [Rated current (A) × 1000]

Electrical characteristics:

| Maximum working voltage | Certification | Rated current (I_N) | Maximum breaking current | | Temperature rise | Current carrying capacity | Overload operation |
|-------------------------|---------------|-------------------------|--------------------------|-------------------|---------------------------|---|--------------------------|
| DC 72 V | — | 100 mA–10 A | 50 A | Resistive circuit | 75 K or less at 1.0 I_N | Until temperature stabilization occurs at 1.0 I_N | Within 60 s at 2.0 I_N |

Typical cold resistance:

| Rated current | Cold resistance | Rated current | Cold resistance | Rated current | Cold resistance |
|---------------|-----------------|---------------|-----------------|---------------|-----------------|
| 100 mA | 1.5 Ω | 500 mA | 240 mΩ | 2.5 A | 35 mΩ |
| 125 mA | 980 mΩ | 630 mA | 190 mΩ | 3.15 A | 26 mΩ |
| 160 mA | 760 mΩ | 800 mA | 140 mΩ | 4 A | 20 mΩ |
| 200 mA | 600 mΩ | 1 A | 100 mΩ | 5 A | 14 mΩ |
| 250 mA | 410 mΩ | 1.25 A | 75 mΩ | 6.3 A | 10 mΩ |
| 315 mA | 350 mΩ | 1.6 A | 64 mΩ | 8 A | 7 mΩ |
| 400 mA | 320 mΩ | 2 A | 48 mΩ | 10 A | 4 mΩ |

Note: These values are for reference only and are not intended to infer any guaranteed values.

Pre-arcing I-t characteristic:

These I-t curve plots are of the average values of the measurements obtained under the conditions specified by our company. These data are for reference only and are not intended to infer any guaranteed values. Characteristics of the protector may vary depending on the usage conditions. Always test the protector under the actual circuit conditions.

Control No.: 100311

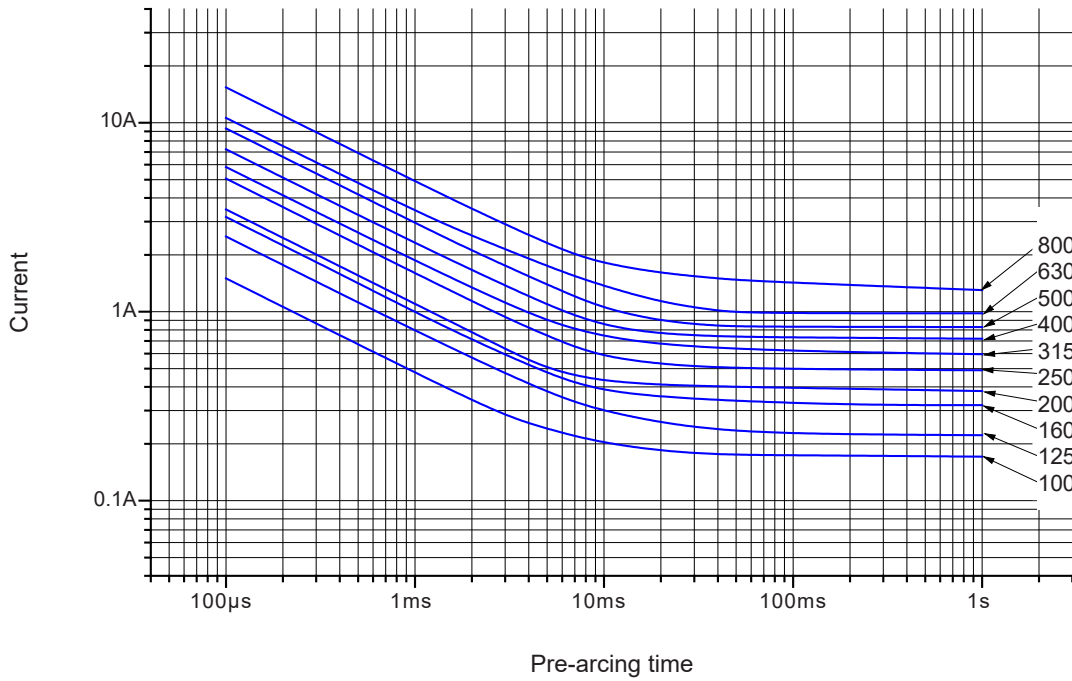

Control No.: 100311

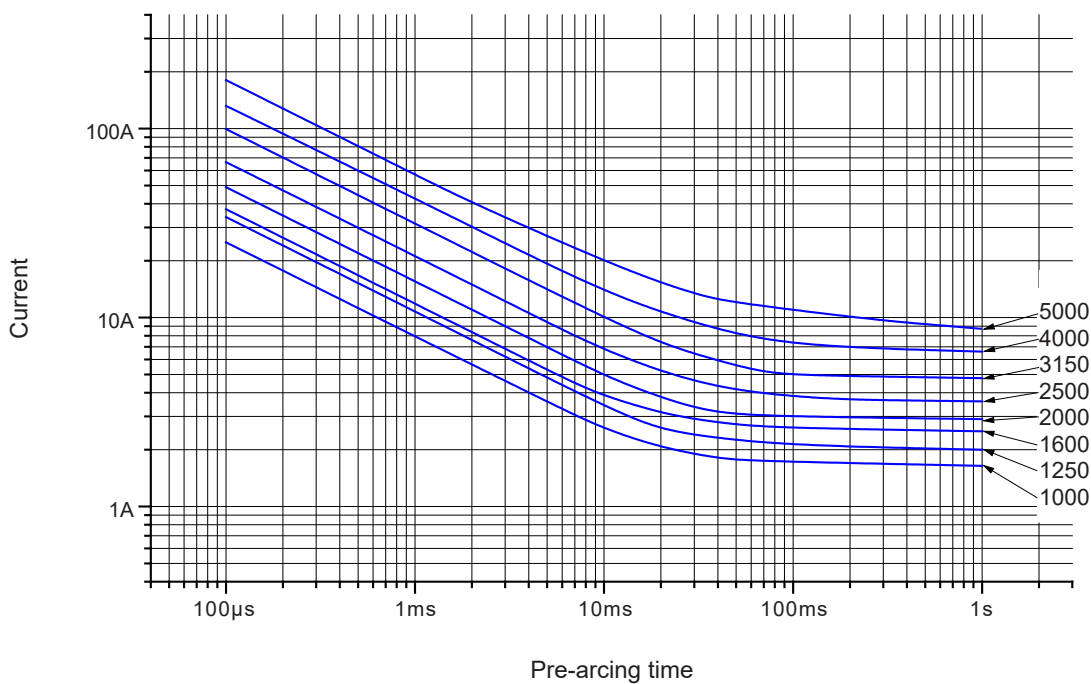

Pre-arcing I-t characteristic:

These I-t curve plots are of the average values of the measurements obtained under the conditions specified by our company. These data are for reference only and are not intended to infer any guaranteed values. Characteristics of the protector may vary depending on the usage conditions. Always test the protector under the actual circuit conditions.

Control No.: 100311

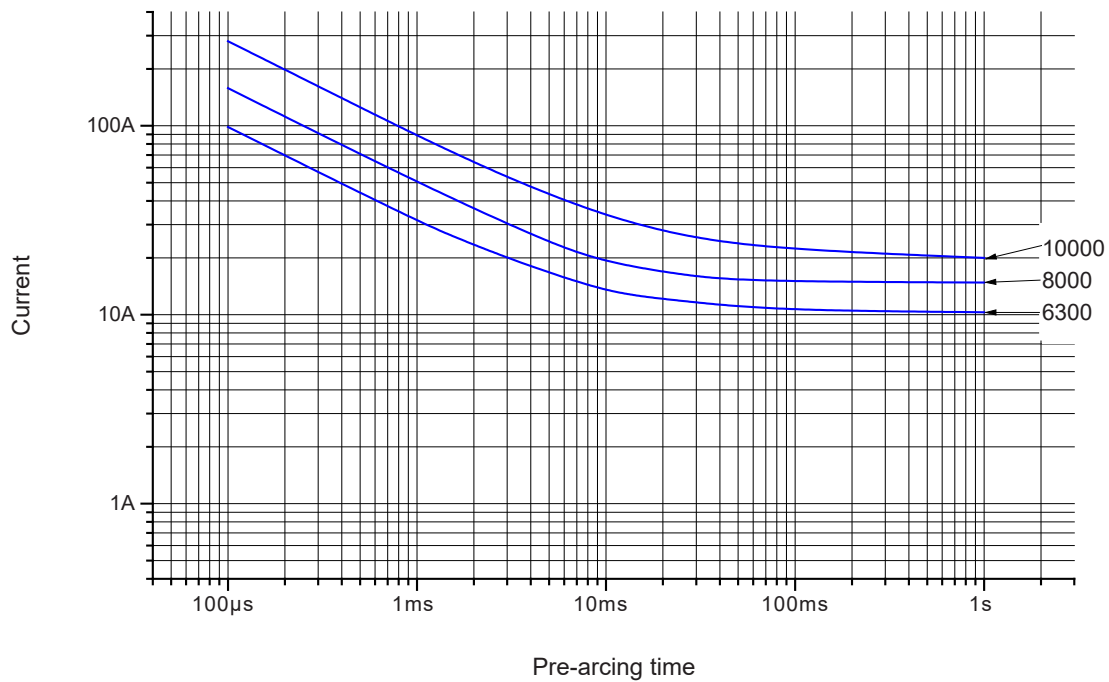

Pre-arcing I^2t -t characteristic:

These I^2t -t curve plots are of the average values of the measurements obtained under the conditions specified by our company. These data are for reference only and are not intended to infer any guaranteed values. Characteristics of the protector may vary depending on the usage conditions. Always test the protector under the actual circuit conditions.

Control No.: 100311

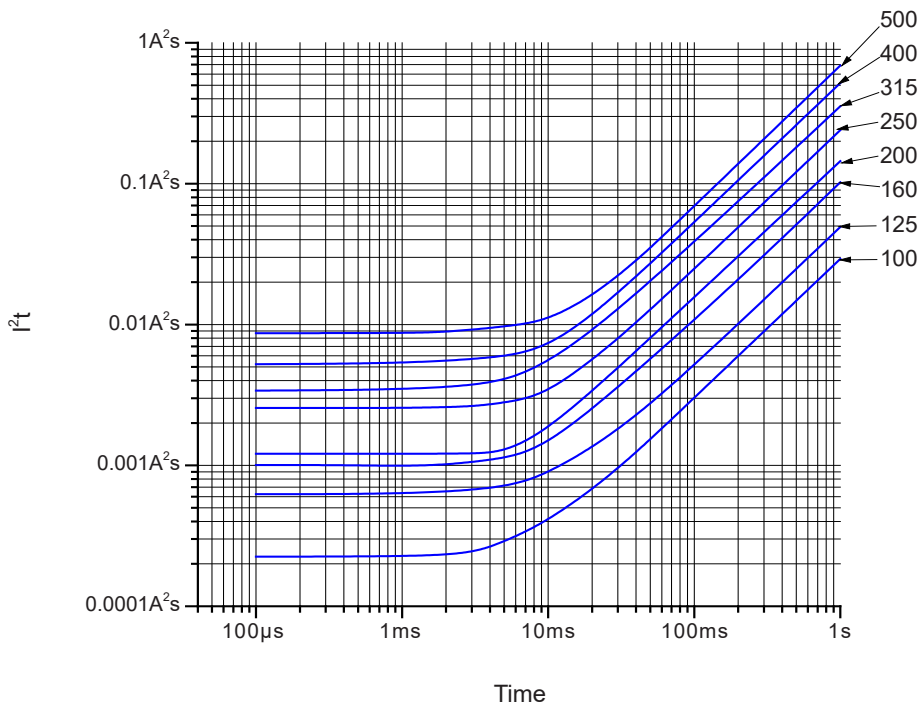

Control No.: 100311

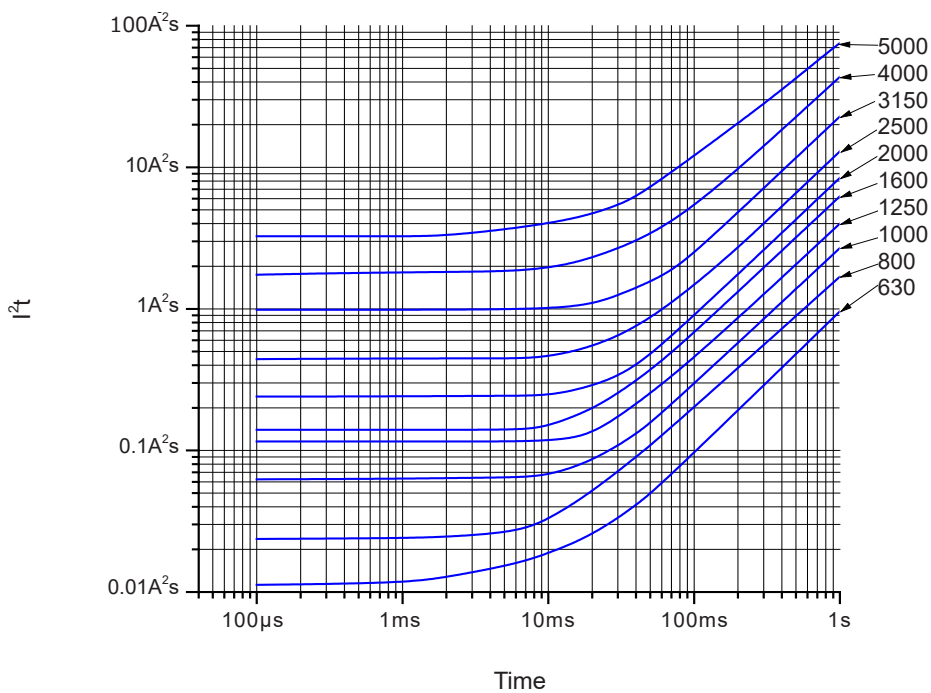

Pre-arcing I^2t -t characteristic:

These I^2t -t curve plots are of the average values of the measurements obtained under the conditions specified by our company. These data are for reference only and are not intended to infer any guaranteed values. Characteristics of the protector may vary depending on the usage conditions. Always test the protector under the actual circuit conditions.

Control No.: 100311

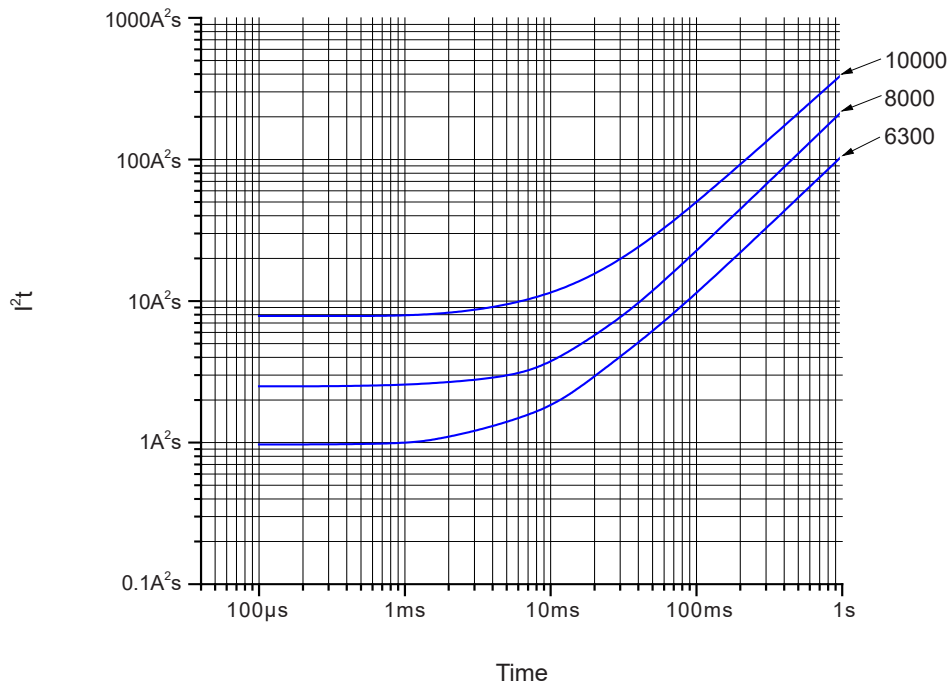

Influence of ambient temperature-the re-rating of the rated current:

This chart is a plot of the measurements obtained at the ambient temperatures of -40 °C, 25 °C, and 105 °C under conditions specified by our company. The conditions of your actual application are not considered in this chart. These data are for reference purposes only and are not intended to infer any guaranteed values. Protector characteristics may vary depending on the usage conditions. Always test the protector under the actual circuit conditions.

Control No.: 170401

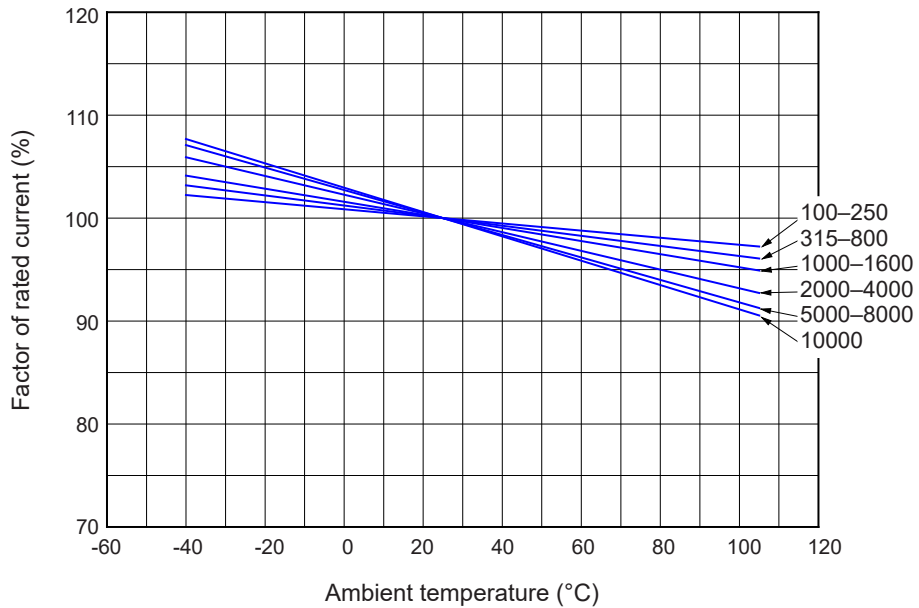

Mounting:

Reflow soldering:

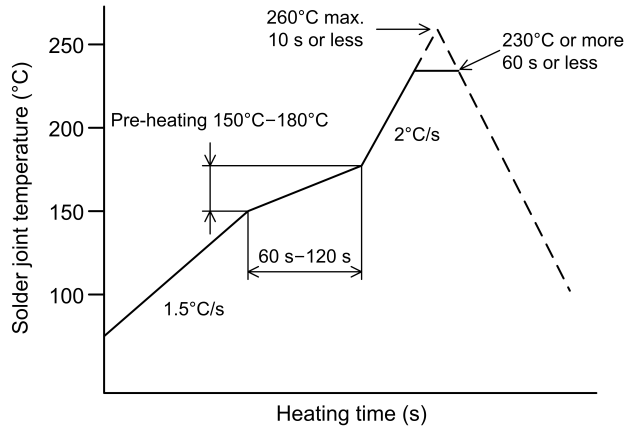

Soldering can be repeated two times under the conditions above.

Hand soldering with soldering iron:

Temperature: 380 °C or less
 Duration: 5 s or less
 Board: Glass fabric base epoxy resin
 t=1.6 mm
 Solder: Sn-3.0Ag-0.5Cu

Land pattern:

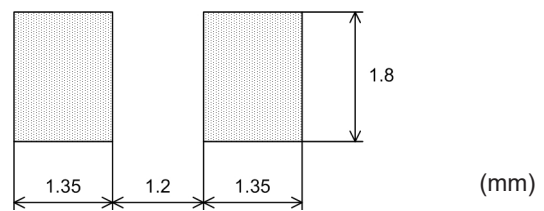

Note: Thickness of the solder paste applied to the board shall be 0.15 mm or less.



Land pattern and soldering conditions described above are examples when facilities in our company are used. Please make sufficient evaluations under the actual conditions in your company because the conditions may vary depending on facilities, solder type, solder quantity, board size, and board material.



Do not touch the terminal directly with a soldering iron. Do not apply any stress on the protector body when the body and/or terminal are/is heated.

Lot number:

The lot number indicates the following:

Example: 17012371 170123: Date manufactured
 71: Process code

Usage conditions:

- * Ambient temperature: -40 °C—+105 °C
- * Ambient humidity: 85% RH or less

Note: Current carrying capacity of the protector may vary depending on the ambient temperature.

Storage conditions and storage period:

Products packaged as delivered can be stored for one year from the date indicated on the packing label under the following conditions:

- * Ambient temperature: -20 °C—+40 °C (no condensation)
- * Ambient humidity: 85% RH or less
- * Ambient atmosphere: Not exposed to corrosive gas or sea breeze
No visible dust
Not exposed to direct sunlight
- * Load: No application of load that may cause deformation or degradation of the product.

Environmental information:

This product conforms to the EU RoHS Directive 2011/65/EU and 2015/863. The ten hazardous substances (lead, mercury, cadmium, hexavalent chromium, poly brominated biphenyls [PBB], poly brominated diphenyl ethers [PBDE], bis phthalate [DEHP], butyl benzyl phthalate [BBP], dibutyl phthalate [DBP] and diisobutyl phthalate [DIBP]) specified in the EU RoHS Directive are not used intentionally in this product. However, when lead is used in applications exempted from the requirements of the Directive, this will be indicated in the Dimensions and Construction section of the corresponding product specification.

Packaging:

Packaging code: R08B4 Products packaged on tape
 B Products packaged in a plastic bag

Carrier tape: Type II-Blister carrier tape with single sprocket holes (the width of the tape is 8 mm) stipulated in JIS C 0806-3 Packaging of Components for Automatic Handling Part 3: Packaging of Surface Mount Components on Continuous Tapes (see Figure 1).

Reel: JEITA ET-7200C Reusable Reel for Packaging of Components for Automatic Handling
 The reel also mostly complies with JIS C 0806-3 Packaging of Components for Automatic Handling-Part 3: Packaging of Surface Mount Components on Continuous Tapes (see Figure 2).

Package quantity: R08B4 2,000 pcs.
 B 100 pcs.

Contents of marking: The following information shall be indicated on one side of the reel.

- Your part number (by request)
- Lot no.
- Quantity of protectors
- Packaged date
- Packaging code
- Country of origin
- Manufacturer
- Production facilities

Figure 1

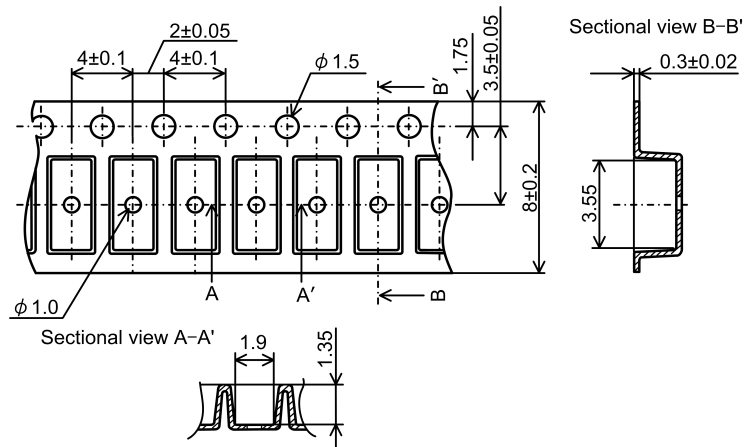
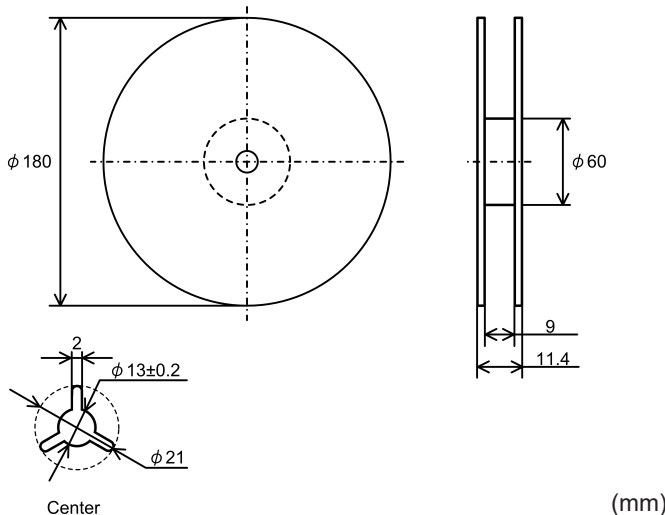

Figure 2



Ordering specifications:

SOC product name: P11CF [rated current (A) × 1000] [packaging code]

Contact information:

SOC is a global ISO9001 and IATF16949 registered company headquartered in Japan with subsidiaries in Asia, Europe, and North America.

SOC Corporation

Marketing Division:

3-16-17, Takanawa, Minato-ku, Tokyo 108-0074, Japan
TEL +81-3-5420-1011 FAX +81-3-5420-6699
<https://www.socfuse.com/contact/index.html>

SOC America Inc.:

414 S Service Rd #519, Patchogue, NY 11772 USA
TEL +1-631-472-6666
<http://www.socamericainc.com>
info@socamericainc.com

SOC Asia Pte. Ltd.:

15 Jalan Kilang Barat, #07-02 Frontech Centre, Singapore 159357
TEL +65-6376-4115
<http://www.socfuse.com/contact/index.html>
socjp@pacific.net.sg

SOC Europe B.V.:

Databankweg 1, 3821 AL Amersfoort, the Netherlands
TEL +31-33-450-4000
<http://www.soceurope.nl>
info@soceurope.nl

Safety Precautions for Fuse Selection and Use: **WARNING**

Read and follow these precautions before selecting and using fuses and protectors (hereafter “fuses”). Failure to properly select, install, and use fuses can result in not only property damage, but also serious injury or death.

Use fuses within their specification requirements. Exposing fuses to conditions that exceed or are outside specifications can lead to, for example, non-operation, nuisance operations, disconnection of the fuse-element, or explosions, and may cause injuries and/or property damage. Please note that breaking conditions for currents below the minimum breaking current and which exceed the rated breaking current are outside the range of the specification conditions. Please use this product after ensuring that the actual breaking conditions in the application are not included in this range.

Fuse performance can vary greatly due to the actual conditions fuses are operated under (ambient temperature, pulse currents, heat shock, mechanical stress, etc.). Please consider all conditions a fuse will be exposed to when making a selection. Depending on the conditions, non-operation, nuisance operations, disconnection of the fuse-element, explosions, or other accidents may occur, and these may cause injuries and/or property damage.

The breaking ability of a fuse will differ between AC and DC circuits. Use fuses with AC voltage ratings in AC circuits and fuses with DC voltage ratings in DC circuits. When using fuses with both AC and DC voltage ratings, attention should be given to any differences in breaking ability. A fuse’s breaking ability indicates the fuse’s ability in an AC or DC circuit. For example, if a fuse with an AC voltage rating is used in a DC circuit, the fuse’s breaking ability will decrease, and injuries and/or property damage may occur.

Check if the circuit voltage is large enough for the fuse’s operation. When the circuit voltage is too small, the decrease in current caused by an increase in the fuse’s resistance may prevent the fuse from operating even for abnormal currents.

Do not use fuses in environments with high humidity or corrosive or flammable gases. Doing so may result in nuisance operations, disconnection of the fuse-element, or an explosion.

Do not use ultrasonic waves to clean fuses. Ultrasonic cleaning may cause disconnection of the fuse-element.

Do not form a fuse’s leads when the fuse is at a temperature of 40 °C or greater. Doing so may result in disconnection of the fuse-element because of the applied stress.

Do not apply coating or potting to any fuses except sealed fuses, such as the MCFA, or their equivalents, including the MCF3. Doing so may cause disconnection of the fuse-element or a change in the fuse’s characteristics. Please be aware that even sealed fuses or the equivalent are not hermetically sealed, and therefore make sure to confirm no coating or potting material has penetrated the interior or any other location of the fuse before use. As coating or potting a fuse will change its characteristics, make sure to confirm that a coated or potted fuse still satisfies all requirements under actual usage conditions.

Avoid applying excessive force when inserting a fuse into a fuse holder. Doing so may result in the fuse cracking or in contact failure, and this may significantly reduce its ability to work properly or may shorten its life.

When a fuse is used in equipment that directly affects human life or that requires a high degree of reliability, more closely examine and evaluate the fuse in actual circuit conditions than is necessary for use in other general electronic equipment.

Do not touch fuses when they are carrying a current. Doing so may result in electrocution or serious burns.

Fuses obtained as samples should only be used for evaluation. Do not reuse fuses, but instead properly dispose of them.

For final fuse selection, make sure to install the fuse in the actual application in order to confirm the selected fuse satisfies all requirements.